

RUBINETTI

- Ricavati da particolari completi di attacchi stampati a caldo o laminati e solubilizzati.
- Ricopertura dei maschi in bagno galvanico con riporto di cromo durissimo e di elevato spessore.
- Elevato grado di conicità negli accoppiamenti per diminuire la pressione specifica di rotazione dei maschi.
- Finitura standard: lucidatura esterna e satinatura interna grana 120. Altre finiture a richiesta.
- Max. pressione di esercizio: 4 bar.

PLUG COCKS

- Made from sections complete with couplings, press-forged or hot-rolled and solution heat-treated.
- Plugs coated in galvanic bath with very hard and thick chrome deposit.
- High degree of taper in the couplings to reduce specific rotation pressure of plugs.
- Standard finish: 120 grain external polishing and internal glazing. Other finishes on request.
- Maximum operating pressure: 4 bars.

ROBINETS

- Obtenus à partir de pièces munies de prises moulées à chaud ou laminées et solubilisées.
- Revêtement des boisseaux dans bain galvanique avec report de chrome extrêmement dur et forte épais.
- Niveau de conicité élevé des assemblages afin de diminuer la pression de rotation spécifique des boisseaux.
- Finissage standard: polissage extérieur et satinage intérieur grain 120. Autres finissages sur demande.
- Pression d'exploitation maximum: 4 bars.

GRIFOS

- Obtenidos de piezas provistas de conexiones estampadas en caliente o laminadas y solubilizadas.
- Recubrimiento de los machos en baño galvánico con agregado de cromo durísimo y de elevado espesor.
- Elevado grado de conicidad en los acoplamientos para disminuir la presión específica de rotación de los machos.
- Acabado estándar: pulido exterior y satinado interior grano 120. A pedido, se pueden suministrar otros acabados.
- Máxima presión de ejercicio: 4 bares.

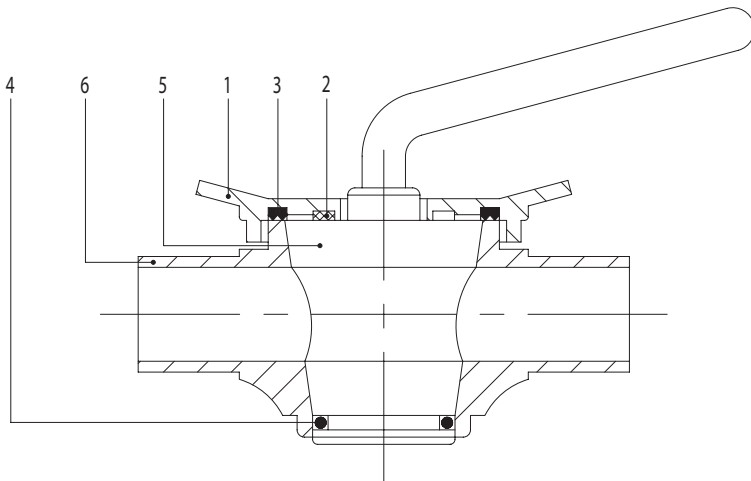
**RUBINETTO 2 VIE
TWO-WAY PLUG COCK**
**ROBINET 2 VOIES
GRIFO 2 VÍAS**

- | | |
|---|---|
| 1. Coperchio
Cover
Couvercle
Tapa | 4. Anello di tenuta OR
OR seal ring
Joint torique
Junta OR |
| 2. Anello PTFE
PTFE ring
Bague PTFE
Junta PTFE | 5. Maschio 2 vie
Two-way plug
Boisseau 2 voies
Macho 2 vías |
| 3. Guarnizione a W
W seal
Joint W
Junta W | 6. Corpo rubinetto 2 vie
Two-way plug casing
Corps robinet 2 voies
Cuerpo grifo 2 vías |

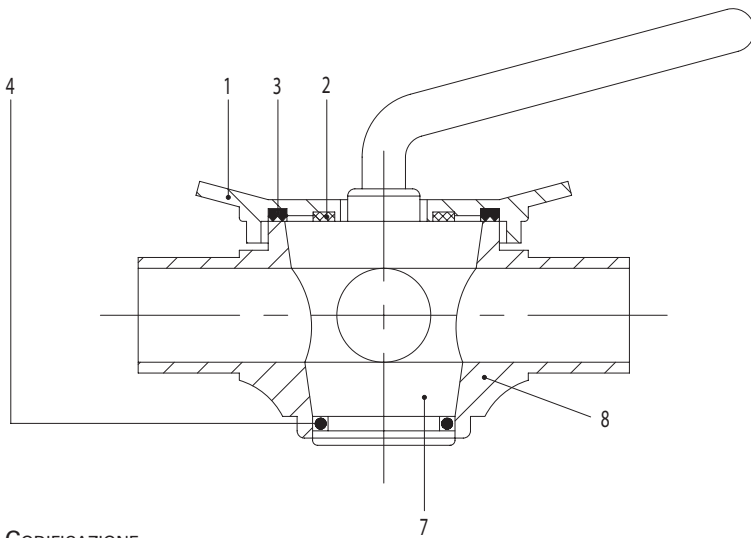
**RUBINETTO 3 VIE
THREE-WAY PLUG COCK**
**ROBINET 3 VOIES
GRIFO 3 VÍAS**

- | | |
|---|---|
| 1. Coperchio
Cover
Couvercle
Tapa | 4. Anello di tenuta OR
OR seal ring
Joint torique
Junta OR |
| 2. Anello PTFE
PTFE ring
Bague PTFE
Junta PTFE | 7. Maschio 3 vie
Three-way plug
Boisseau 3 voies
Macho 3 vías |
| 3. Guarnizione a W
W seal
Joint W
Junta W | 8. Corpo rubinetto 3 vie
Three-way plug casing
Corps robinet 3 voies
Cuerpo grifo 3 vías |

CODIFICAIONE
CODING
CODIFICATION
CODIFICACIÓN

Pos.	Cod. base	Norme	1" 25	D 25 28	D 32 34	1 1/2" 38	D 40 40	2" 51	D 50 52	2 1/2" 63	D 65 70	3" 76	D 80 85	4" 101	D 100 101	Mat.	Part. o agg.
1	500		25/28	25/28	34/40	34/40	34/40	51/52	51/52	63/70	63/70	76/85	76/85	101	101	4L/6L	01
2	500		25/28	25/28	34/40	34/40	34/40	51/101	51/101	51/101	51/101	51/101	51/101	51/101	51/101	T	02
3	500		25/28	25/28	34/40	34/40	34/40	51/52	51/52	63/70	63/70	76/85	76/85	101	101	E	03
4	OR		4106	4106	153	153	153	162	162	6312	6312	185	185	204	204	E	
5	500		25/28	25/28	34/40	34/40	34/40	51/52	51/52	63/70	63/70	76/85	76/85	101	101	4L/6L	05
6	500	L	25	28	34	38	40	51	52	63	70	76	85	101	101	4L/6L	06
7	510		25/28	25/28	34/40	34/40	34/40	51/52	51/52	63/70	63/70	76/85	76/85	101	101	4L/6L	07
8	510	L	25	28	34	38	40	51	52	63	70	76	85	101	101	4L/6L	08



RUBINETTI 2 VIE
TWO-WAY PLUG COCKS

ROBINETS 2 VOIES
GRIFOS 2 VÍAS

DIN

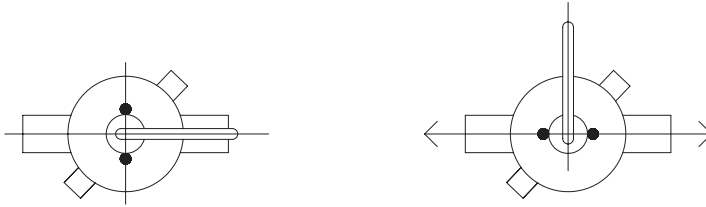

SMS BS ISS



RUBINETTI 3 VIE
THREE-WAY PLUG COCKS

ROBINETS 3 VOIES
GRIFOS 3 VÍAS

DIN

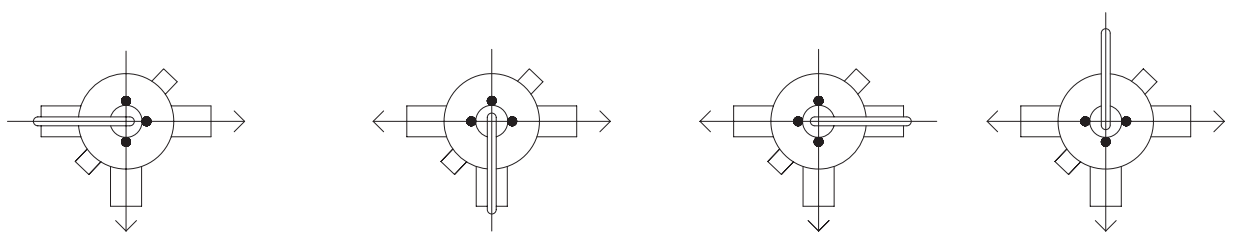

SMS BS ISS

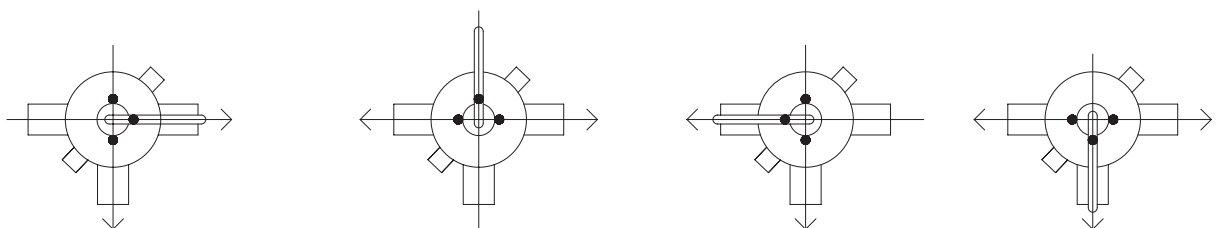



RUBINETTO PRELIEVO SANITARIO
 ROBINET PRISE ÉCHANTILLON SANITAIRE
 SANITARY SAMPLING PLUG
 GRIFO TOMAMUESTRAS SANITARIO

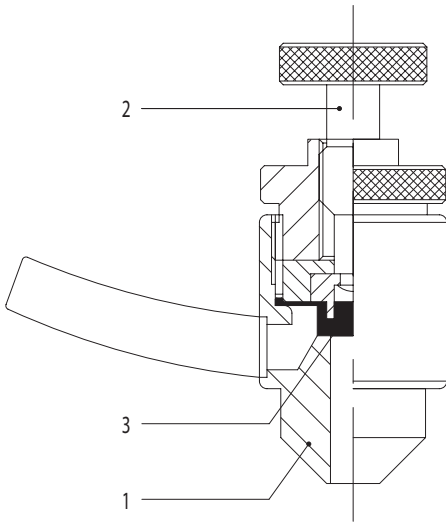

- 1. Corpo rubinetto
 Plug casing
 Corps du robinet
 Cuerpo grifo
- 2. Maschio
 Plug
 Boisseau
 Macho
- 3. Guarnizione
 Seal
 Joint
 Junta

CODIFICAIONE
 CODING
 CODIFICATION
 CODIFICACIÓN

Pos.	Cod. base	Norme	1/2"	Mat.	Part. o agg.
1	36	W	8	6L	01
1	36	K	12	6L	01
1	36	G	1/4"	6L	01
2	36		12	6L	02
3	36		12	S	03



RUBINETTO PRELIEVO CURVA
 ROBINET PRISE ÉCHANTILLON COUDE
 SAMPLING PLUG BEND
 GRIFO TOMAMUESTRAS CODO

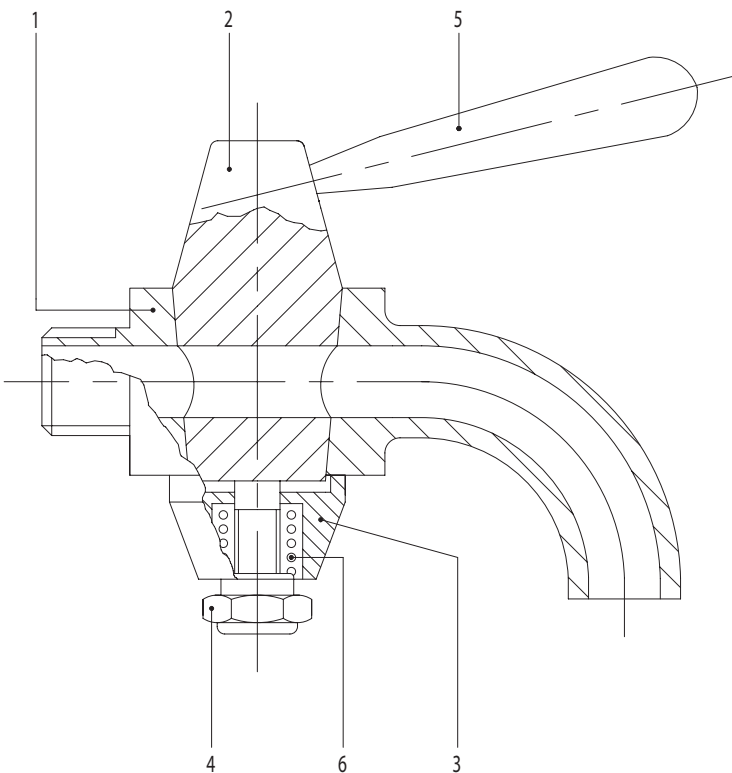

- | | |
|--|---|
| 1. Corpo rubinetto
Plug casing
Corps du robinet
Cuerpo grifo | 4. Dado autobloccante
Self-locking nut
Écrou de sûreté
Tuerca de seguridad |
| 2. Maschio
Plug
Boisseau
Macho | 5. Maniglia
Handle
Poignée
Maneta |
| 3. Bussola portamolla
Spring holder
Porte-ressort
Portamuelle | 6. Molla
Spring
Ressort
Muelle |

CODIFICAIONE
 CODING
 CODIFICATION
 CODIFICACIÓN

Pos.	Cod. base	Norme	1/4"	3/8"	1/2"	Mat.	Part. o agg.
1	033	G	14	38	12	6L	01
2	033		14/38	14/38	12	6L	02
3	033		14/38	14/38	12	6L	03
4	033		14/38	14/38	12	4L	04
5	033		14/12	14/12	14/12	4L	05
6	033		14/38	14/38	12	4L	06



PORTALIVELLO SUPERIORE
 M. SUPÉRIEUR DE NIVEAU
 UPPER LEVEL GAUGE
 GRIFO NIVEL SUPERIOR

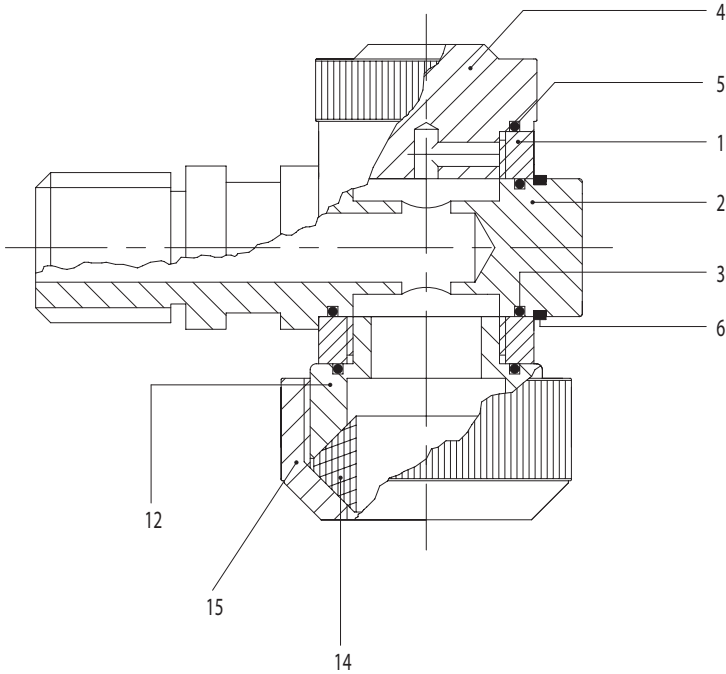

- | | |
|---|---|
| 1. Corpo rubinetto
Plug casing
Corps du robinet
Cuerpo grifo | 6. Seeger
Snap ring
Circlips
Anillo seeger |
| 2. Tampone
Plug
Tampon
Tapón | 12. Bussola portavetro
Glass holder
Porte-verre
Portavidrio |
| 3. Anello di tenuta OR
OR seal ring
Joint torique
Junta OR | 14. Guarnizione vetro
Glass seal
Joint verre
Junta vidrio |
| 4. Tappo scarico aria
Air vent plug
Bouchon décharge air
Tapón descarga aire | 15. Ghiera serravetro
Glass locking collar
Bague blocage verre
Tuerca bloqueo vidrio |
| 5. Anello di tenuta OR
OR seal ring
Joint torique
Junta OR | |

CODIFICAIONE
 CODING
 CODIFICATION
 CODIFICACIÓN

Pos.	Cod. base	Norme	1/2"	Mat.	Part. o agg.
1	047		12	6L	01
2	047	G	12	6L	02
3	OR		2056	N	
4	038		12	6L	04
5	OR		2068	N	
6	SEE		A 18	4L	
12	038		12	6L	12
14	038		12	S/V	14
15	038		12	A/4L	15

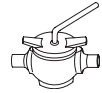

**RUBINETTO PORTALIVELLO
ROBINET DE NIVEAU
LOWER LEVEL GAUGE
GRIFO NIVEL**

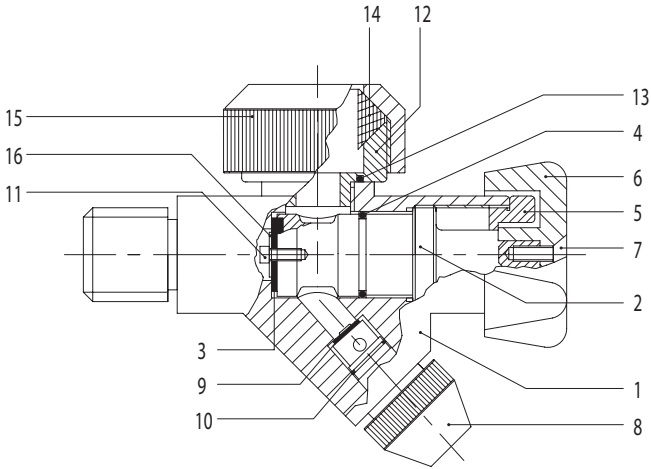

- | | |
|---|---|
| 1. Corpo rubinetto
Plug casing
Corps du robinet
Cuerpo grifo | 9. Guarnizione scarico
Drain seal
Joint de drainage
Junta drenaje |
| 2. Tampone
Plug
Tampon
Tapón | 10. Anello di tenuta OR
OR seal ring
Joint torique
Junta OR |
| 3. Guarnizione tampone
Plug seal
Joint tampon
Junta tapón | 11. Vite
Screw
Vis
Tornillo |
| 4. Anello di tenuta OR
OR seal ring
Joint torique
Junta OR | 12. Bussola portavetro
Glass holder
Porte-verre
Portavidrio |
| 5. Ghiera di bloccaggio
Locking collar
Bague de blocage
Tuerca de seguridad | 13. Anello di tenuta OR
OR seal ring
Joint torique
Junta OR |
| 6. Manopola
Handle
Poignee
Maneta | 14. Guarnizione vetro
Glass seal
Joint verre
Junta vidrio |
| 7. Vite
Screw
Vis
Tornillo | 15. Ghiera serravetro
Glass locking collar
Bague blocage verre
Tuerca bloqueo vidrio |
| 8. Ugello di prelievo
Sampling nozzle
Buse prélèvement
Boquilla tomamuestras | 16. Rondella
Washer
Rondelle
Arandela |

CODIFICAZIONE
CODING
CODIFICATION
CODIFICACIÓN

Pos.	Cod. base	Norme	1/2"	Mat.	Part. o agg.
1	038	G	12	6L	01
2	038		12	6L	02
3	038		12	E	03
4	OR		3050	N	
5	038		12	A	05
6	038		12	A	06
7	TSV		M4x10	4L	
8	038		12	6L	08
9	038		12	E	09
10	OR		2043	N	
11	TCCE		M3x6	4L	
12	038		12	6L	12
13	OR		2068	N	
14	038		12	S/V	14
15	038		12	A/4L	15
16	RON		RP3	4L	

**RUBINETTO 2 VIE EL.
PLUG COCK 2-WAY PE.
ROBINET 2 VOIES BL.
GRIFO 2 VÍAS EL.**

500 L

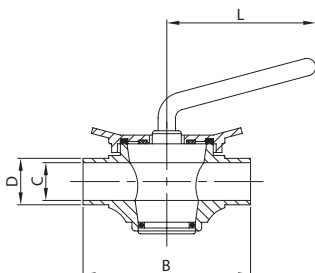

DN	B	C	D	L	gr
28	125,0	25,0	28,0	100,0	1.950
34	160,0	31,0	34,0	115,0	3.050
40	160,0	37,0	40,0	115,0	4.250
52	170,0	49,0	52,0	140,0	6.050
70	200,0	66,0	70,0	160,0	12.600
85	230,0	81,0	85,0	160,0	16.100

**RUBINETTO 2 VIE EF.
PLUG COCK 2-WAY ME.
ROBINET 2 VOIES BF.
GRIFO 2 VÍAS ER.**

501 D

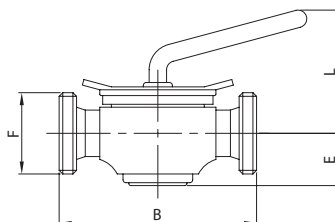

DN	B	E	F	L	gr
25	125,0	38,0	52-6	90,0	2.100
32	160,0	45,0	58-6	117,0	3.400
40	160,0	45,0	65-6	117,0	4.700
50	170,0	55,0	78-6	122,0	6.600
65	200,0	68,0	95-6	142,0	13.350
80	230,0	71,0	110-4	154,0	17.350

**RUB. 2 VIE EF./FLANGIA
PLUG C. 2-WAY ME./FLANGE
ROBINET 2 VOIES BF./BRIDE
GRIFO 2 VÍAS ER./BRIDA**

504 D

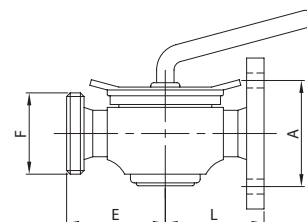

DN	A	E	F	L	gr
25	75,0	62,5	52-6	72,0	2.600
32	90,0	80,0	58-6	89,5	4.150
40	100,0	80,0	65-6	89,5	5.500
50	110,0	85,0	78-6	94,5	7.400
65	130,0	100,0	95-6	109,5	14.300
80	150,0	115,0	110-4	124,5	18.800

**RUBINETTO 3 VIE EL.
PLUG COCK 3-WAY PE.
ROBINET 3 VOIES BL.
GRIFO 3 VÍAS EL.**

510 L

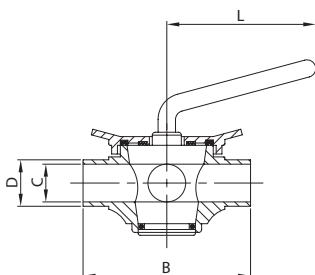

DN	B	C	D	L	gr
28	125,0	25,0	28,0	100,0	2.050
34	160,0	31,0	34,0	115,0	4.500
40	160,0	37,0	40,0	115,0	4.500
52	170,0	49,0	52,0	140,0	6.100
70	200,0	66,0	70,0	160,0	12.400
85	230,0	81,0	85,0	160,0	17.100

**RUBINETTO 3 VIE EF.
PLUG COCK 3-WAY ME.
ROBINET 3 VOIES BF.
GRIFO 3 VÍAS ER.**

511 D

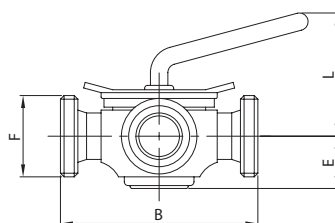

DN	B	E	F	L	gr
25	125,0	38,0	52-6	90,0	2.150
32	160,0	45,0	58-6	117,0	5.000
40	160,0	45,0	65-6	117,0	5.000
50	170,0	55,0	78-6	122,0	6.750
65	200,0	68,0	95-6	142,0	13.350
80	230,0	71,0	110-4	154,0	17.600

**RUB. 3 VIE EF./EF./FL.
PLUG C. 3-WAY ME./ME./FL.
ROBINET 3 VOIES BF./BF./BR.
GRIFO 3 VÍAS ER./ER./BR.**

514 D

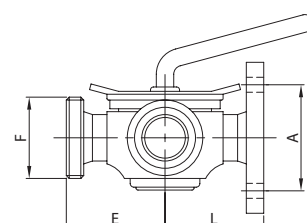

DN	A	E	F	L	gr
25	75,0	62,5	52-6	72,0	2.650
32	90,0	80,0	58-6	89,5	6.000
40	100,0	80,0	65-6	89,5	6.100
50	110,0	85,0	78-6	94,5	7.800
65	130,0	100,0	95-6	109,5	14.700
80	150,0	115,0	110-4	124,5	19.600



RUBINETTO 2 VIE EL.
PLUG COCK 2-WAY PE.
ROBINET 2 VOIES BL.
GRIFO 2 VÍAS EL.

500 L

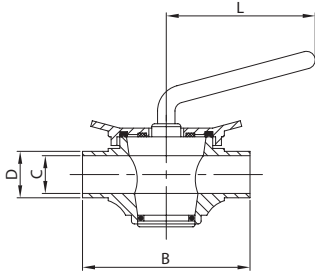

DN	B	C	D	L	gr
25	125,0	22,4	25,4	100,0	1.950
38	160,0	35,1	38,1	115,0	4.250
51	170,0	47,8	50,8	140,0	6.050
63	200,0	60,5	63,5	160,0	12.600
76	230,0	72,9	76,2	160,0	16.150

RUBINETTO 2 VIE EF.
PLUG COCK 2-WAY ME.
ROBINET 2 VOIES BF.
GRIFO 2 VÍAS ER.

501 S

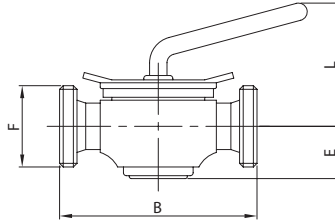

DN	B	E	F	L	gr
25	125,0	38,0	40-6	90,0	1.950
38	160,0	45,0	60-6	117,0	4.250
51	170,0	55,0	70-6	122,0	6.450
63	200,0	68,0	85-6	142,0	13.650
76	230,0	71,0	98-6	154,0	18.400

RUB. 2 VIE EF./FLANGIA
PLUG C. 2-WAY ME./FLANGE
ROBINET 2 VOIES BF./BRIDE
GRIFO 2 VÍAS ER./BRIDA

504 S

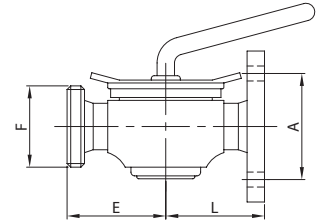

DN	A	E	F	L	gr
25	75,0	62,5	40-6	72,0	2.600
38	90,0	80,0	60-6	89,5	5.450
51	110,0	85,0	70-6	94,5	7.300
63	130,0	100,0	85-6	109,5	15.000
76	150,0	115,0	98-6	124,5	18.800

RUBINETTO 3 VIE EL.
PLUG COCK 3-WAY PE.
ROBINET 3 VOIES BL.
GRIFO 3 VÍAS EL.

510 L

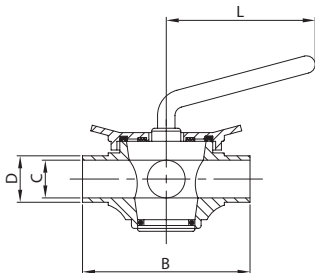

DN	B	C	D	L	gr
25	125,0	22,4	25,4	100,0	2.050
38	160,0	35,1	38,1	115,0	4.450
51	170,0	47,8	50,8	140,0	6.100
63	200,0	60,5	63,5	160,0	12.350
76	230,0	72,9	76,2	160,0	17.000

RUBINETTO 3 VIE EF.
PLUG COCK 3-WAY ME.
ROBINET 3 VOIES BF.
GRIFO 3 VÍAS ER.

511 S

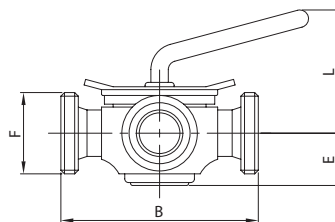

DN	B	E	F	L	gr
25	125,0	38,0	40-6	90,0	2.150
38	160,0	45,0	60-6	117,0	3.850
51	170,0	55,0	70-6	122,0	6.750
63	200,0	68,0	85-6	142,0	12.800
76	230,0	71,0	98-6	154,0	16.550

RUB. 3 VIE EF./EF./FL.
PLUG C. 3-WAY ME./ME./FL.
ROB. 3 VOIES BF./BF./BR.
GRIFO 3 VÍAS ER./ER./BR.

514 S

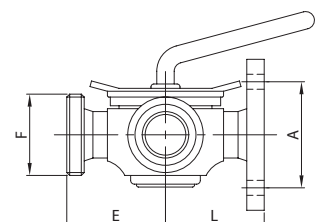

DN	A	E	F	L	gr
25	75,0	62,5	40-6	72,0	2.650
38	90,0	80,0	60-6	89,5	6.000
51	110,0	85,0	70-6	94,5	7.800
63	130,0	100,0	85-6	109,5	15.300
76	150,0	115,0	98-6	124,5	19.600

RUBINETTO 2 VIE EL.
PLUG COCK 2-WAY PE.
ROBINET 2 VOIES BL.
GRIFO 2 VÍAS EL.

500 L

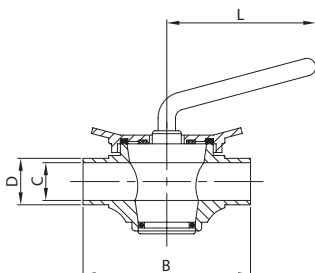

DN	B	C	D	L	gr
25	125,0	22,4	25,4	100,0	1.950
38	160,0	35,1	38,1	115,0	4.250
51	170,0	47,8	50,8	140,0	6.050
63	200,0	60,5	63,5	160,0	12.600
76	230,0	72,9	76,2	160,0	16.150

RUBINETTO 2 VIE EF.
PLUG COCK 2-WAY ME.
ROBINET 2 VOIES BF.
GRIFO 2 VÍAS ER.

501 B

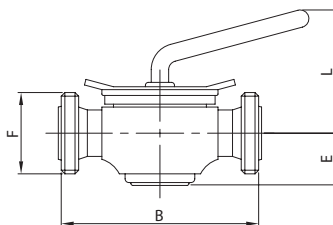

DN	B	E	F	L	gr
25	125,0	38,0	46-8	90,0	1.950
38	160,0	45,0	58-8	117,0	4.250
51	170,0	55,0	73-6	122,0	6.450
63	200,0	68,0	85-6	142,0	13.650
76	230,0	71,0	98-6	154,0	18.400

RUB. 2 VIE EF./FLANGIA
PLUG C. 2-WAY ME./FLANGE
ROBINET 2 VOIES BF./BRIDE
GRIFO 2 VÍAS ER./BRIDA

504 B

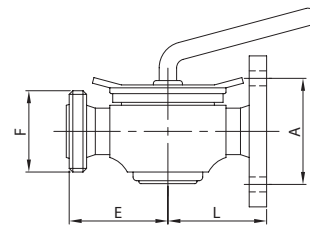

DN	A	E	F	L	gr
25	75,0	60,5	46-8	72,0	2.600
38	90,0	80,0	58-8	89,5	5.450
51	110,0	89,0	73-6	94,5	7.300
63	130,0	100,0	85-6	109,5	15.000
76	150,0	115,0	98-6	124,5	18.800

RUBINETTO 3 VIE EL.
PLUG COCK 3-WAY PE.
ROBINET 3 VOIES BL.
GRIFO 3 VÍAS EL.

510 L

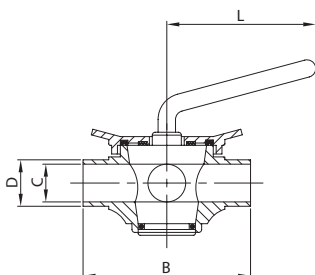

DN	B	C	D	L	gr
25	125,0	22,4	25,4	100,0	2.050
38	160,0	35,1	38,1	115,0	4.450
51	170,0	47,8	50,8	140,0	6.100
63	200,0	60,5	63,5	160,0	12.350
76	230,0	72,9	76,2	160,0	17.000

RUBINETTO 3 VIE EF.
PLUG COCK 3-WAY ME.
ROBINET 3 VOIES BF.
GRIFO 3 VÍAS ER.

511 B

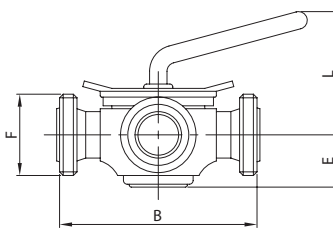

DN	B	E	F	L	gr
25	125,0	38,0	46-8	90,0	2.350
38	160,0	45,0	58-8	117,0	4.900
51	170,0	55,0	73-6	122,0	6.950
63	200,0	68,0	85-6	142,0	13.250
76	230,0	71,0	98-6	154,0	16.550

RUB. 3 VIE EF./EF./FL.
PLUG C. 3-WAY ME./ME./FL.
ROB. 3 VOIES BF./BF./BR.
GRIFO 3 VÍAS ER./ER./BR.

514 B

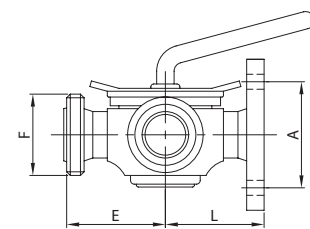

DN	A	E	F	L	gr
25	75,0	60,5	46-8	72,0	2.650
38	90,0	80,0	58-8	89,5	6.000
51	110,0	89,0	73-6	94,5	7.900
63	130,0	100,0	85-6	109,5	14.600
76	150,0	115,0	98-6	124,5	19.400



RUBINETTO 2 VIE EL.
PLUG COCK 2-WAY PE.
ROBINET 2 VOIES BL.
GRIFO 2 VÍAS EL.

500 L

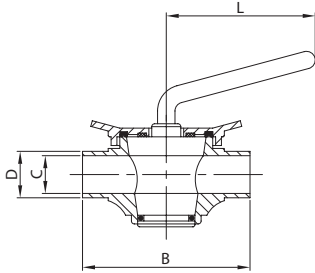

DN	B	C	D	L	gr
25	125,0	22,4	25,4	100,0	1.950
38	160,0	35,1	38,1	115,0	4.250
51	170,0	47,8	50,8	140,0	6.050
63	200,0	60,5	63,5	160,0	12.600
76	230,0	72,9	76,2	160,0	16.150

RUBINETTO 2 VIE EF.
PLUG COCK 2-WAY ME.
ROBINET 2 VOIES BF.
GRIFO 2 VÍAS ER.

501 I

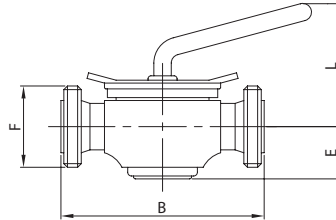

DN	B	E	F	L	gr
25	125,0	38,0	37-8	90,0	1.950
38	160,0	45,0	50-8	117,0	4.250
51	170,0	55,0	64-8	122,0	6.450
63	200,0	68,0	77-8	142,0	13.650
76	230,0	71,0	91-8	154,0	18.400

RUB. 2 VIE EF./FLANGIA
PLUG C. 2-WAY ME./FLANGE
ROBINET 2 VOIES BF./BRIDE
GRIFO 2 VÍAS ER./BRIDA

504 I

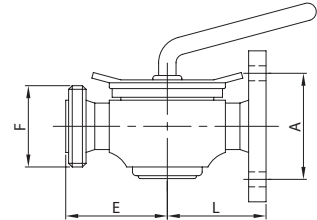

DN	A	E	F	L	gr
25	75,0	62,5	37-8	72,0	2.600
38	90,0	80,0	50-8	89,5	5.450
51	110,0	85,0	64-8	94,5	7.300
63	130,0	100,0	77-8	109,5	15.000
76	150,0	115,0	91-8	124,5	18.800

RUBINETTO 3 VIE EL.
PLUG COCK 3-WAY PE.
ROBINET 3 VOIES BL.
GRIFO 3 VÍAS EL.

510 L

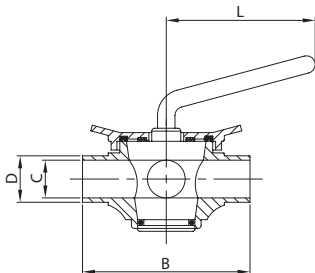

DN	B	C	D	L	gr
25	125,0	22,4	25,4	100,0	2.050
38	160,0	35,1	38,1	115,0	4.450
51	170,0	47,8	50,8	140,0	6.100
63	200,0	60,5	63,5	160,0	12.350
76	230,0	72,9	76,2	160,0	17.000

RUBINETTO 3 VIE EF.
PLUG COCK 3-WAY ME.
ROBINET 3 VOIES BF.
GRIFO 3 VÍAS ER.

511 I

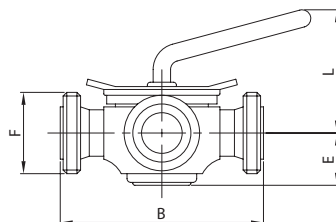

DN	B	E	F	L	gr
25	125,0	38,0	37-8	90,0	2.350
38	160,0	45,0	50-8	117,0	4.900
51	170,0	55,0	64-8	122,0	6.950
63	200,0	68,0	77-8	142,0	13.250
76	230,0	71,0	91-8	154,0	16.550

RUB. 3 VIE EF./EF./FL.
PLUG C. 3-WAY ME./ME./FL.
ROB. 3 VOIES BF./BF./BR.
GRIFO 3 VÍAS ER./ER./BR.

514 I

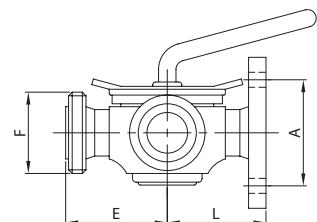

DN	A	E	F	L	gr
25	75,0	62,5	37-8	72,0	2.650
38	90,0	80,0	50-8	89,5	6.000
51	110,0	85,0	64-8	94,5	7.900
63	130,0	100,0	77-8	109,5	14.600
76	150,0	115,0	91-8	124,5	19.400

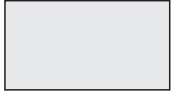
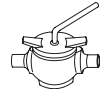

RUB. PREL. SANIT. GAS
 SANIT. SAMPL. PLUG BSP
 R. PRISE E. SANIT. GAS
 GRIFO T. SANIT. GAS

G36

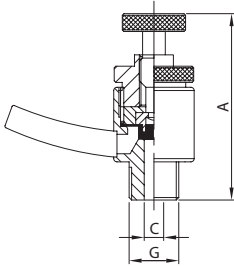

DN	A	C	G	gr
14	57,6	6,0	1/4"	120

RUB. PREL. SANIT. EL.
 SANIT. SAMPL. PLUG PE.
 R. PRISE E. SANIT. BL.
 GRIFO T. SANIT. EL.

W36

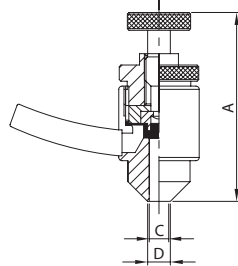

DN	A	C	D	gr
8	57,6	6,0	8,0	120

RUB. PREL. SANIT. E. SM.
 SANIT. SAMPL. PLUG E. FR.
 R. PRISE E. SANIT. B. FR.
 GRIFO T. SANIT. E. SM.

K36

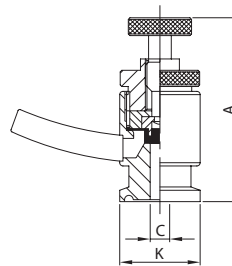

DN	A	C	K	gr
1/2" 12	57,6	9,4	25,0	120

RUB. PRELIEVO CURVA
 SAMPLE COCK BEND
 ROB. PRISE COUDE
 GRIFOTOMAM. CODO

033 G

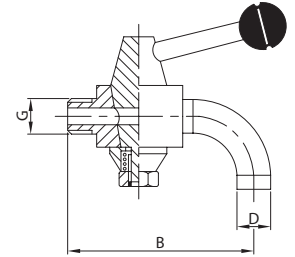

DN	B	D	G	gr
14	60,0	11,0	1/4"	175
38	60,0	11,0	3/8"	185
12	68,0	13,7	1/2"	330

RUB. PRELIEVO NPT
 SAMPLING PLUG NPT
 R. PRISE ECHANTILLON NPT
 GRIFO TOMAM. NPT

T33

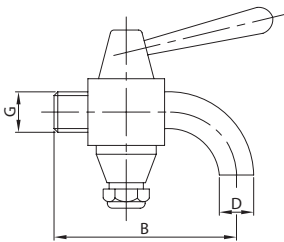

DN	B	D	G	gr
1 1/2" 38	78,0	11,0	3/8"	185

RUB. PRELIEVO E. SM.
 SAMPLING PLUG E. FR.
 R. PRISE ECHANTIL. B. FR.
 GRIFO TOMAM. E. SM.

K33

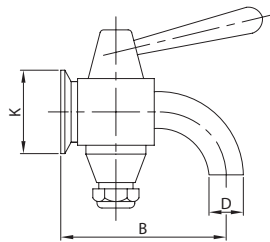

DN	B	D	K	gr
1" 25	68,0	11,0	50,5	200

RUB. PRELIEVO NPT
 SAMPLING PLUG NPT
 R. PRISE ECHANTILLON NPT
 GRIFO TOMAM. NPT

T33 R

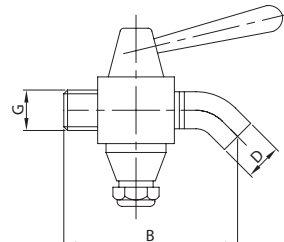

DN	B	D	G	gr
1 1/2" 38	84,0	11,0	3/8"	185

RUB. PRELIEVO E. SM.
 SAMPLING PLUG E. FR.
 R. PRISE ECHANTIL. B. FR.
 GRIFO TOMAM. E. SM.

K33 R

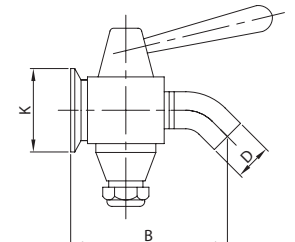

DN	B	D	K	gr
1" 25	76,0	11,0	50,5	200



PORTALIVELLO SUP. GAS
 UPPER LEVEL GAUGE BSP
 M. SUP. DE NIVEAU GAS
 GRIFO NIVEL SUP. GAS

047 G

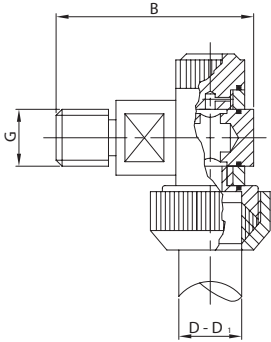

DN	B	D	D ₁	G	gr
12	66,5	22,0	16,0	1/2"	275

PORTALIVELLO SUP. FL.
 UPPER LEVEL GAUGE FL.
 M. SUP. DE NIVEAU BR.
 GRIFO NIVEL SUP. BRIDA

047 F/O

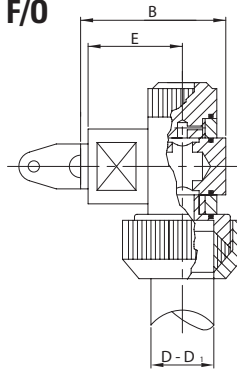

DN	B	D	D ₁	E	gr
1/2"	51,5	22,0	16,0	30,0	340

PORTALIVELLO SUP. NPT
 UPPER LEVEL GAUGE NPT
 M. SUP. DE NIVEAU NPT
 GRIFO NIVEL SUP. NPT

T47

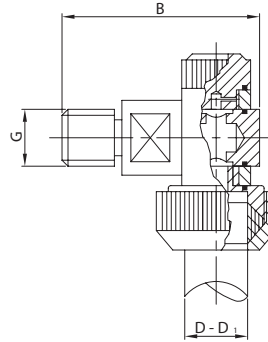

DN	B	D	D ₁	G	gr	
1 1/2"	38	66,5	16,0	22,0	3/8"	275

PORTALIVELLO SUP. E. SM.
 UPPER LEVEL GAUGE E. FR.
 M. SUP. DE NIVEAU B. FR.
 GRIFO NIVEL SUP. E. SM.

K47

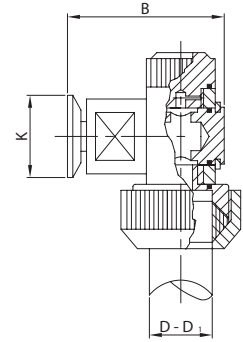

DN	B	D	D ₁	K	gr	
1"	25	56,5	16,0	22,0	50,5	300

RUB. PORTALIVELLO GAS
 LOWER LEVEL GAUGE BSP
 ROBINET DE NIVEAU GAS
 GRIFO NIVEL GAS

038 G

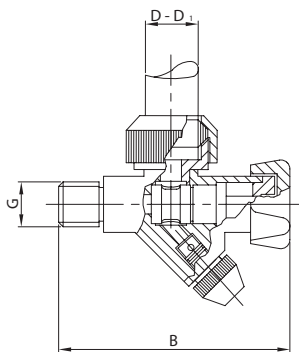

DN	B	D	D ₁	G	gr
12	105,0	22,0	16,0	1/2"	515

RUB. PORTALIVELLO FL.
 LOWER LEVEL GAUGE FL.
 ROBINET DE NIVEAU BR.
 GRIFO NIVEL BRIDA

038 F/O

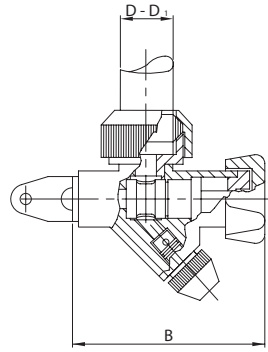

DN	B	D	D ₁	gr
1/2"	91,0	22,0	16,0	520

RUB. PORTALIVELLO NPT
 LOWER LEVEL GAUGE NPT
 ROB. DE NIVEAU NPT
 GRIFO NIVEL NPT

T38

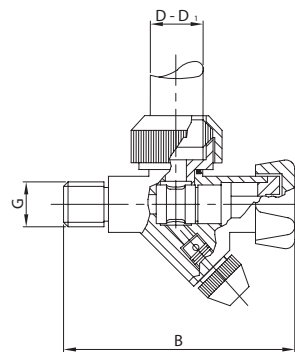

DN	B	D	D ₁	G	gr	
1 1/2"	38	110,0	16,0	22,0	3/8"	515

RUB. PORTALIVELLO E. SM.
 LOWER LEVEL GAUGE E. FR.
 ROB. DE NIVEAU B. FR.
 GRIFO NIVEL E. SM.

K38

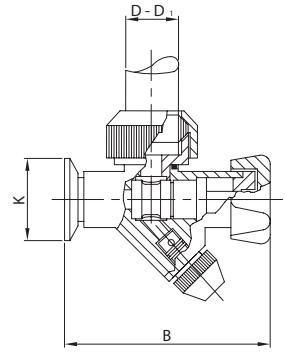

DN	B	D	D ₁	K	gr	
1"	25	99,0	16,0	22,0	50,5	530

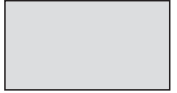
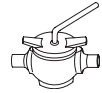

RUB. PREL. PORTAGOMMA
 SAMPL. PLUG HOSE CONN.
 ROB. PRISE É. M. LIGAT.
 GRIFO TOMAM. M. M.

032 G

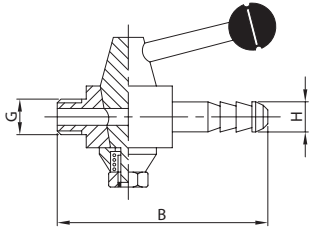

DN	B	G	H	gr
14	70,0	1/4"	12,0	170
38	83,0	3/8"	12,0	180
12	106,0	1/2"	15,0	320

RUB. PRELIEVO F. MA./FE.
 SAMPL. PLUG T. MA./FE.
 ROB. PRISE É. T. MA./FE.
 GRIFO TOMAM. R. M./H.

032 GMF

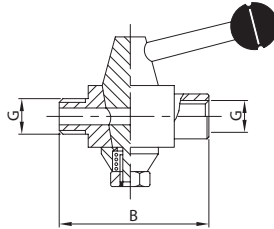

DN	B	G	gr
12	56,0	1/2"	340

RUBINETTO PRELIEVO
 SAMPLING PLUG
 ROBINET PRISE ÉCH.
 GRIFO TOMAMUESTRAS

048 G

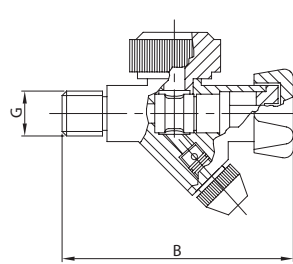

DN	B	G	gr
12	105,0	1/2"	490

RUBINETTO PRELIEVO
 SAMPLING PLUG
 ROBINET PRISE ÉCH.
 GRIFO TOMAMUESTRAS

048 F/O

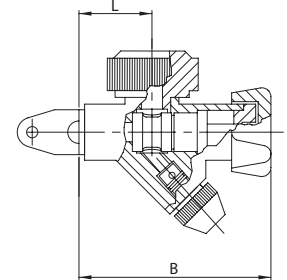

DN	B	L	gr
1/2"	91,0	30,0	460

FLANGIA OVALE
 OVAL FLANGE
 BRIDE OVALE
 BRIDA OVAL

F/O

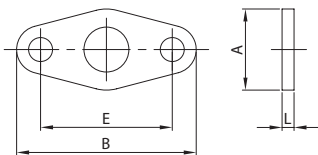

DN	A	B	E	L	gr
1/2"	30,0	60,0	43,0	6,0	20

